

FORMULA

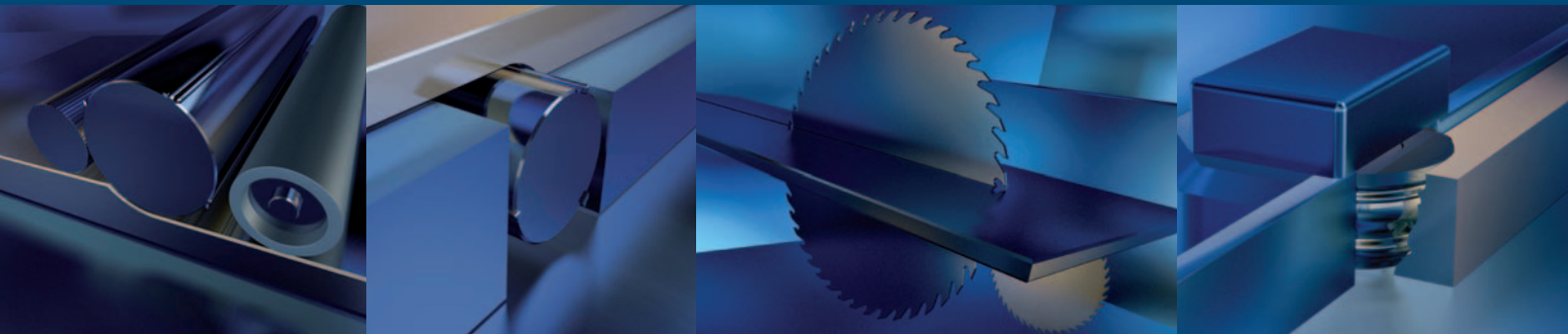

Circular saws



Surface planers



Thicknessing planers



Combined planer-thicknesser machines



Spindle moulders with fixed or tilting spindle

FORMULA

100% made in Italy

A product range of SCM Group

FORMULA - The best value for your investment

The **Formula** line is the new, bigger range of professional wood-working machines, for use in small- or medium-sized workshops. The technic and technologic solutions took by **Formula** derive directly from machines of higher brand: this assures performances, functionality, quality and user-friendliness.

The range includes planers and thicknessers, combined planer-thicknesser, spindle moulders with fixed or tilting spindles and circular saws.

Formula machines are available at a competitive price, and thanks to the various optional features, can be configured to suit most professional requirements.

FORMULA - The certainty of being part of a great industrial group

Formula is an **SCM** group brand. The 50 years of success enjoyed by this leading company bring unique advantages.

All this means for the customer:

- Reliable solutions
- Prestige
- An after sales service always close to the customer



SINERT



Formula **S30 S40 S40M** circular saws

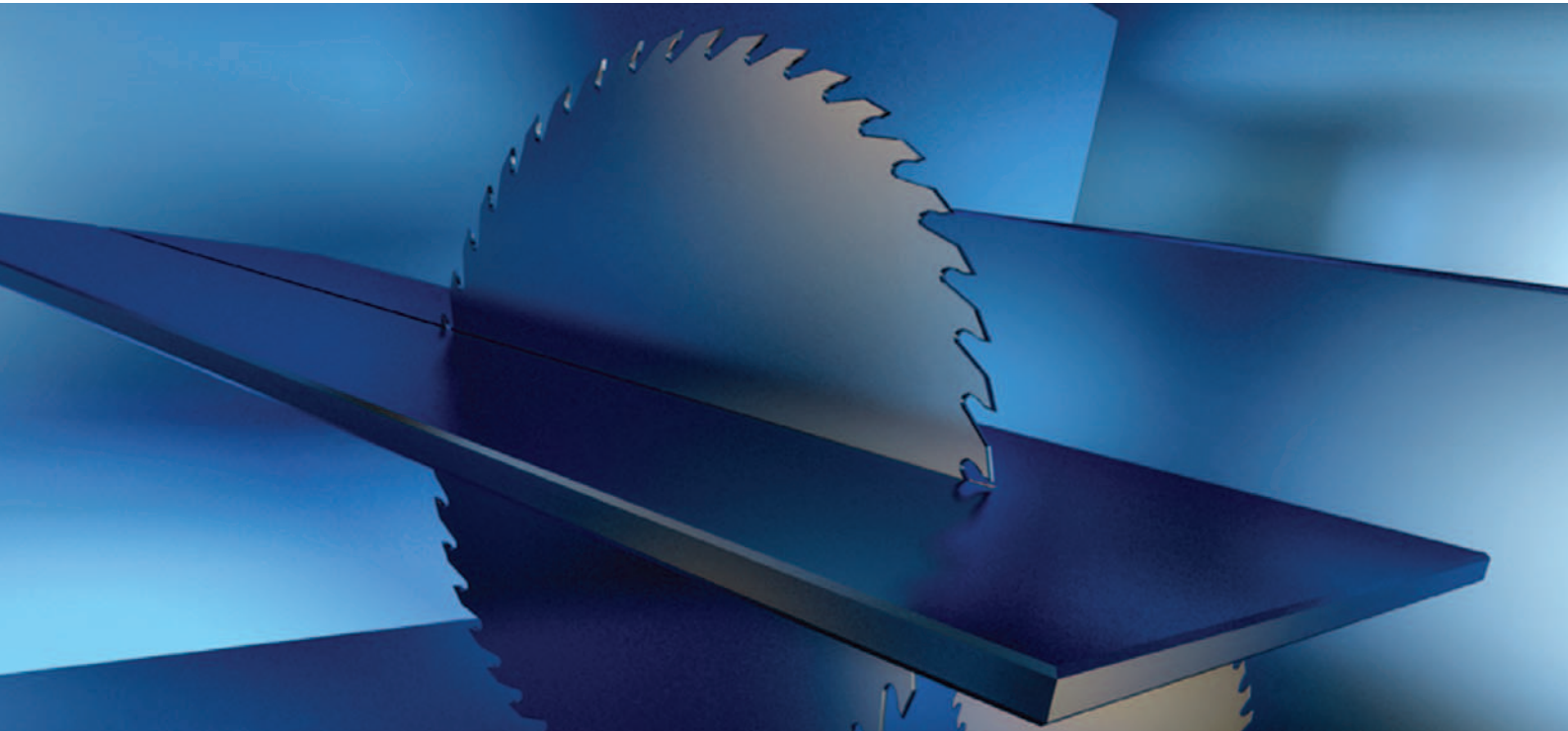

The operators, in order to obtain a high quality finished product, require a machine enabling them to work efficiently, comfortably and precisely. Formula provides all this. Each machine is fitted with exclusive solutions designed specifically for this purpose. The carriage slides very smoothly, the saw unit has the same features as an automatic panel saw and the unit is easily adjusted from the front of the machine.

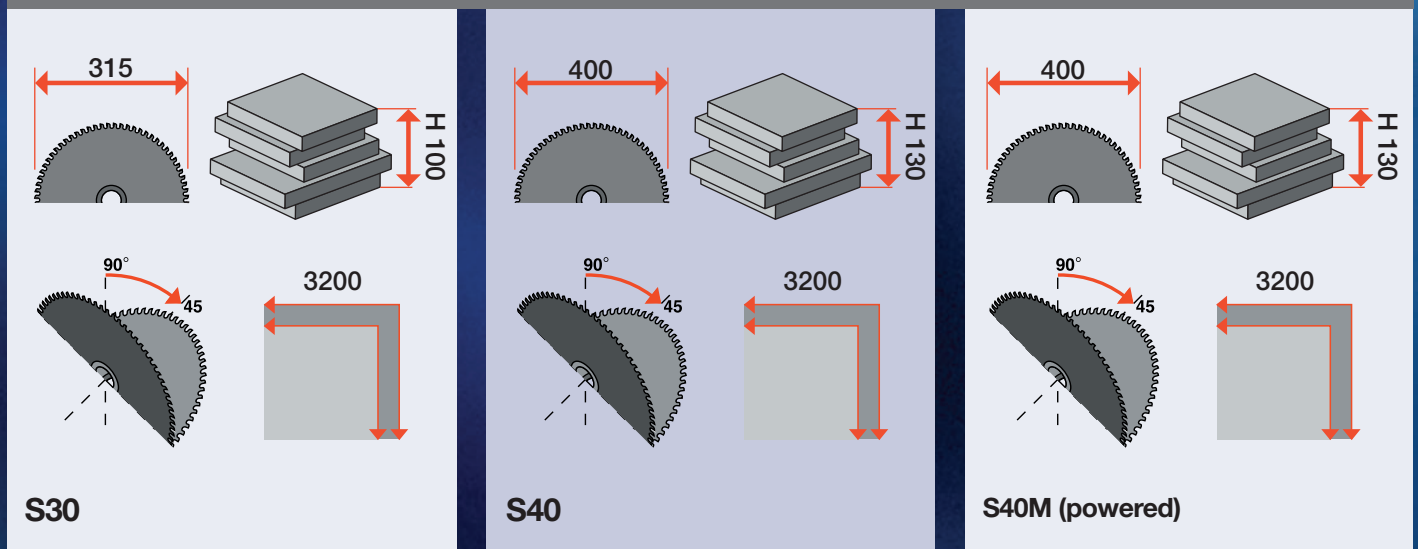

Formula **S30 S40 S40M** circular saws

A perfect cut at all time!



Frontal group movement

Standard saw-table extension on all versions

Telescopic squaring rule complete with two reversible stops

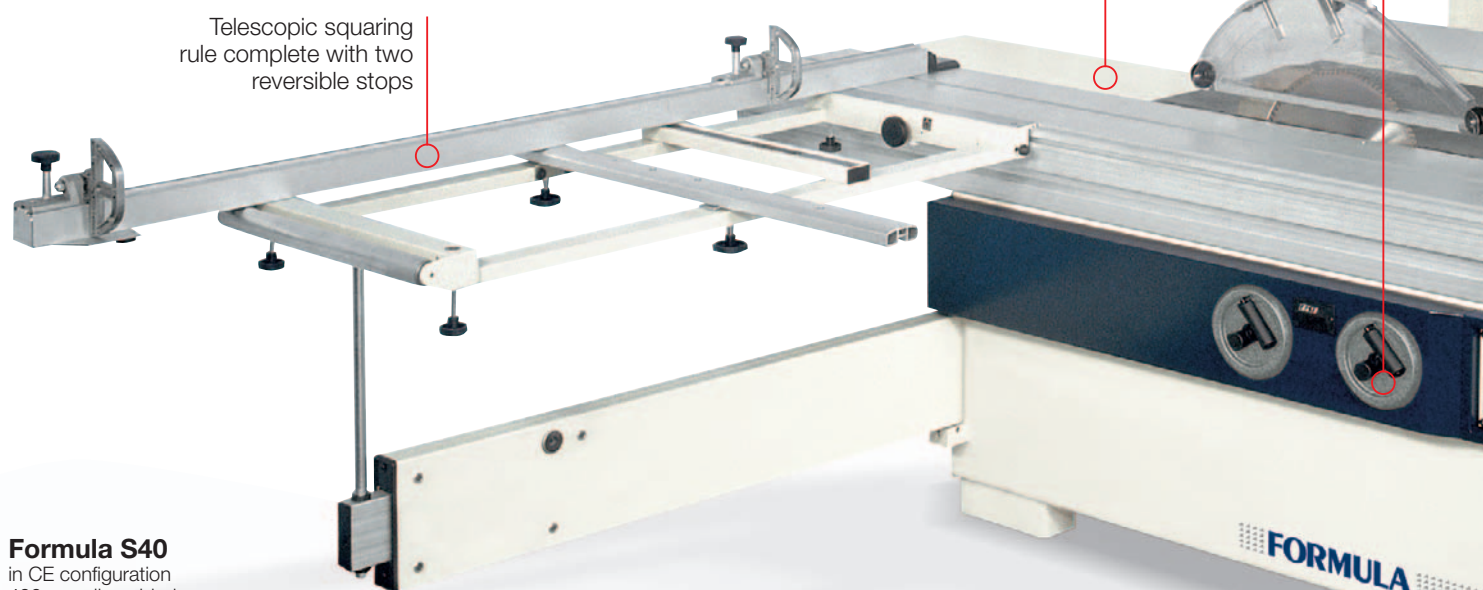

Formula S40
in CE configuration
400 mm diam. blade
130 mm cutting height
with motorized parallel fence and
electronic positioning (optional)

FORMULA



Formula S30
in CE configuration
315 mm diam. blade
100 mm cutting height



Formula S40M
in CE configuration
400 mm diam. blade
130 mm cutting height
with electronic readout for rip fence
position (optional)

Anodized aluminium rip fence with
cutting capacity up to 1270 mm
(1500 optional)

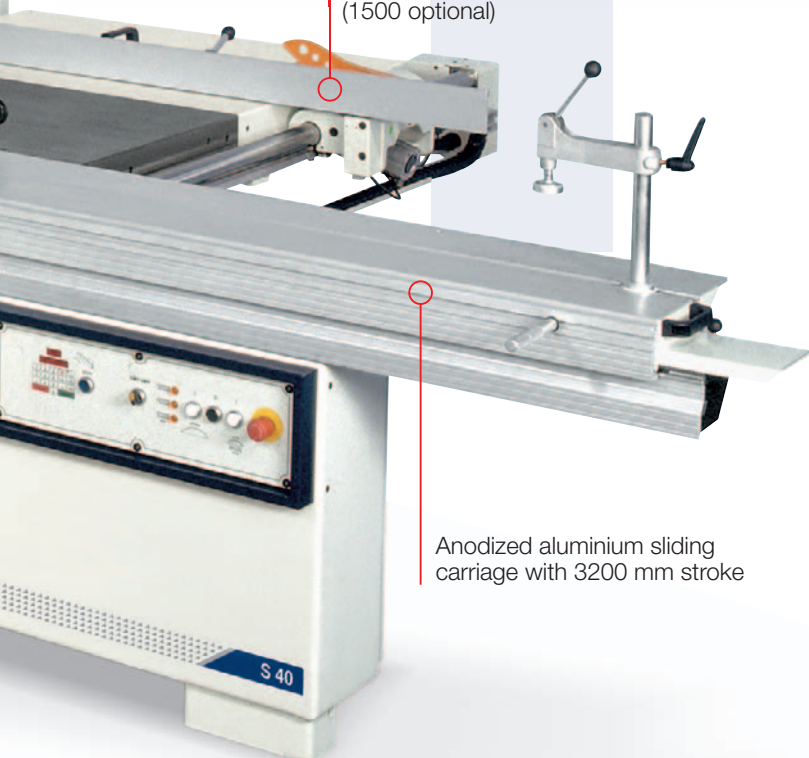

Anodized aluminium sliding
carriage with 3200 mm stroke



S40M control panel with switches for saw unit lifting and
tilting and electronic digital readouts

The quality showed in the details

Saw unit

A large structure, an hardened cast iron worktable and an innovative operator unit prevent vibration to ensure excellent finishing. Height adjustment using rounded guides ensures smooth operation even after years of use. All controls are located at the front of the machine for easy access and to ensure further time savings in the preparation process.

Scoring unit adjustment

The scoring unit is moved vertically and horizontally using a lever system to ensure the complete absence of play. This system also enables rapid positioning thus limiting the need for sawing tests.

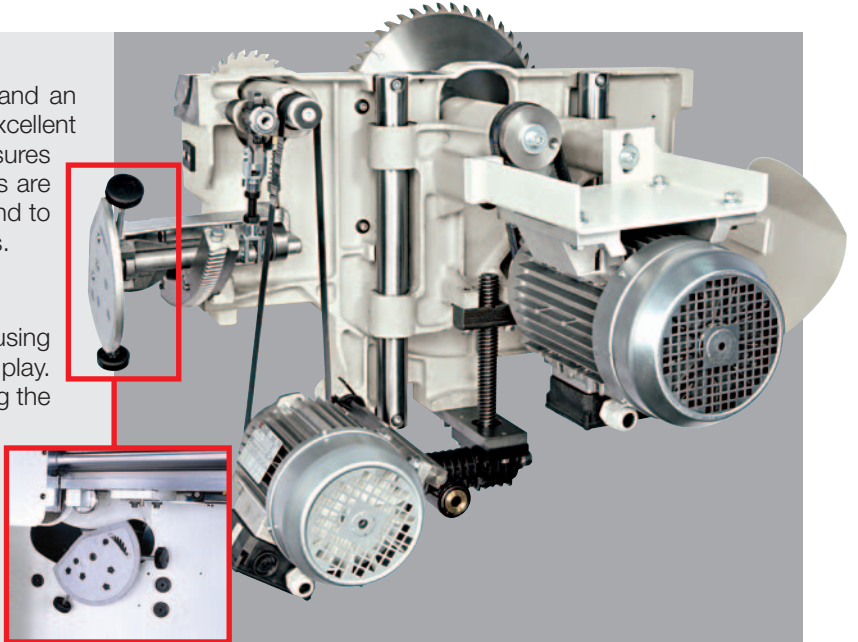

Carriage

Above all the carriage must slide easily and ensure precision and durability. Formula circular saws are fitted with an exclusive sliding system. Sturdy aluminium profiles with hardened steel guides fitted using rivets enable straight line precision of ± 0.05 mm along the entire length of the carriage. The result is considerable: the same precision after years of intensive use without maintenance.

5 year warranty

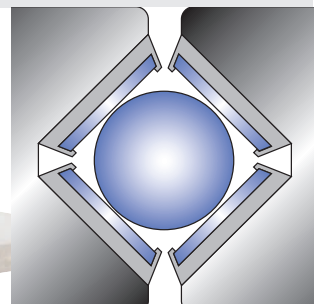

Exclusive system!

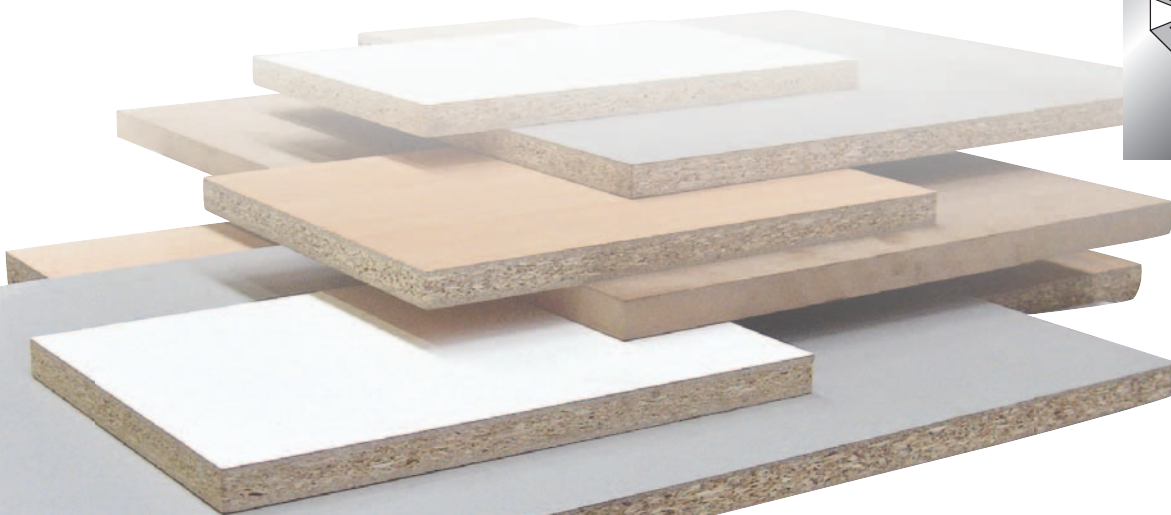

Formula S30 S40 S40M

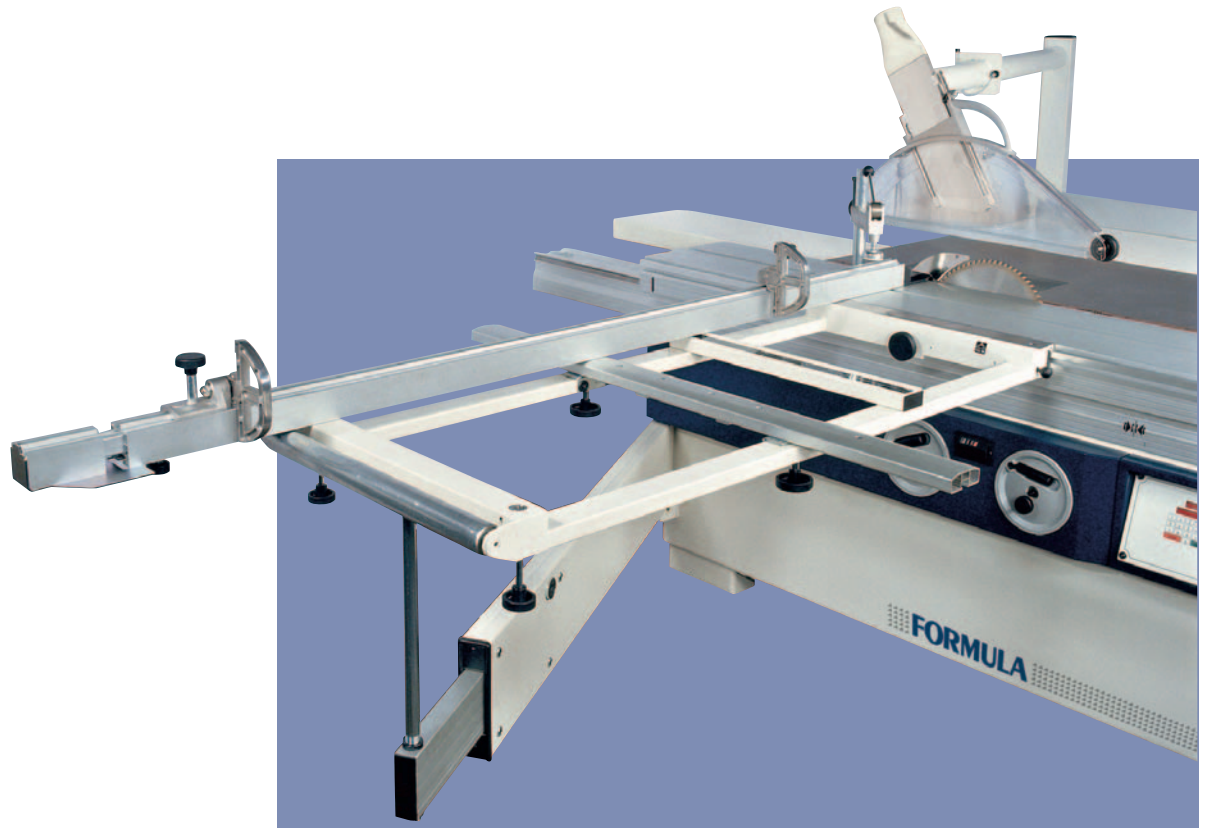

Squaring unit frame

Large design enables squaring of panels up to 3200 x 3200 mm.

It is fitted with a straight line guide complete with two reversible stops and an idle roller to facilitate the loading of large panels. The straight line guide also enables angular cutting up to 45°.



Main options available on request



Angular cutting device equipped with:
- telescopic fence with two flip-over stops
- pre-set for angle selection



Angular cutting device with automatic stop position compensation relative to the blade. Each time the cutting angle is adjusted so that the distance between the stop and the blade remains constant. This enables rapid set-up and reduces test cutting.

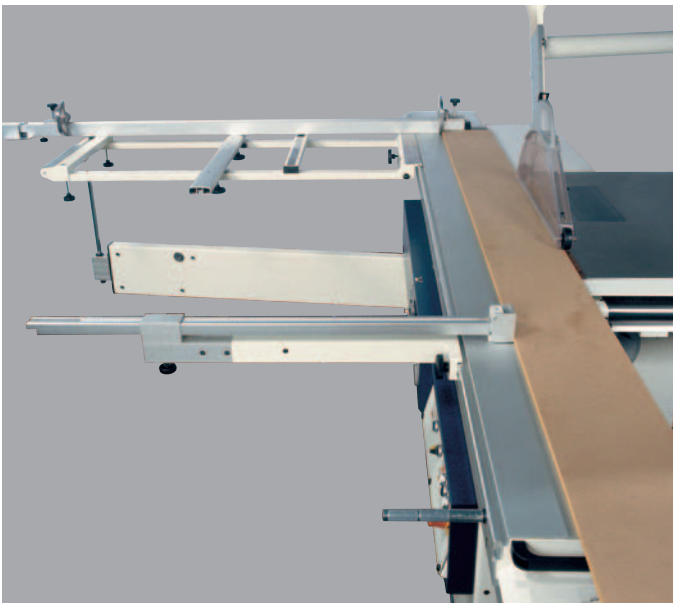

Rip cuts unit
Particularly useful with trim cuts on long pieces.



Suspended blade guard
Fitted in a tilted position to increase the useful cutting width to the parallel guide. An elegant solution for maximum flexibility.

Standard on S40 and S40M in CE version
Optional on S30

Formula **S30 S40 S40M**

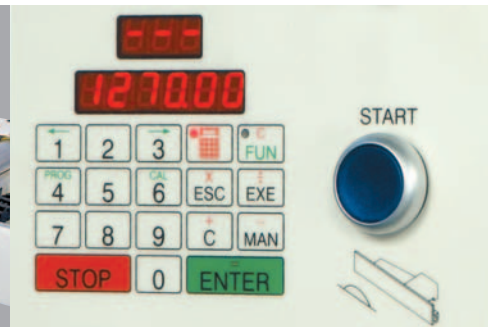
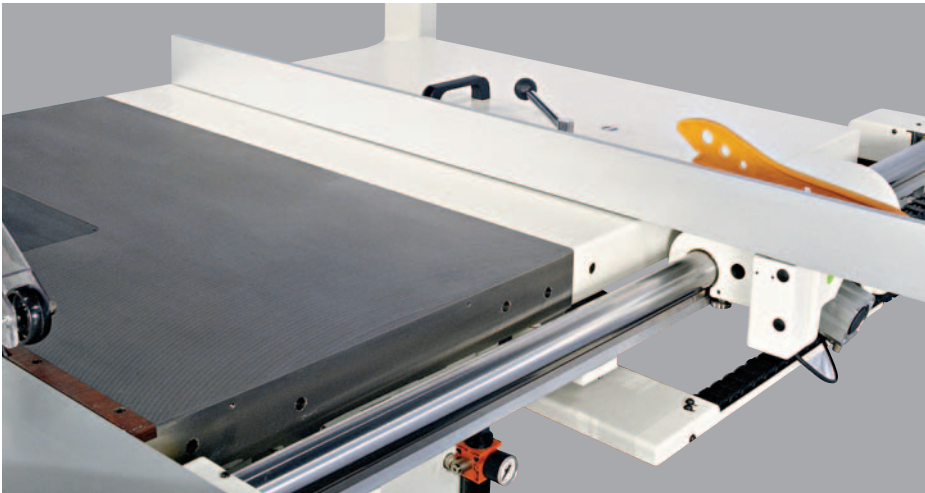

Motorized parallel fence with electronic positioning

Easy and precise positioning from numeric keyboard: by pushing a button the fence rapidly reach the requested position which is visualized on the electronic display.

For S40 and S40M only



Electronic readout for rip fence position

System for reading the current fence position from a magnetic band. Relative and micrometric adjustments are also possible.

For S40 and S40M only

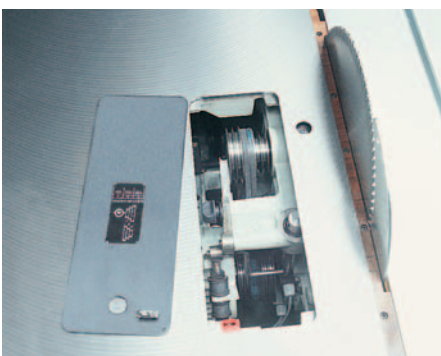

Three saw blade rotating speeds

The speed change can be made easily from the opening on the worktable.

Standard on S40M
Optional on S40

Technical details



		S30	S40	S40M
Cutting capacity	mm	3200	3200	3200
Stop on fence for cuts extendable to	mm	3200	3200	3200
Standard cutting width with rip fence	mm	1270	1270	1270
Main blade diameter (hole)	mm	315 (30)	400 (30)	400 (30)
Scoring blade diameter (hole)	mm	120 (20)	120 (20)	120 (20)
Max. blade cutting height at 90°	mm	100	130	130
Max. blade cutting height at 45°	mm	70	92	92
Blade speed rotation	rpm	4000	3700	3000/4000/5000
Scoring blade speed rotation	rpm	8500	8500	8500
Blade tilting	degrees	90/45	90/45	90/45
Diameter of exhaust outlet at base	mm	120	120	120
Blade protection with exhaust outlet diameter (CE)	mm	60	60 (CE 80)	60 (CE 80)

Electrical features and Options

3x400V	●	●	●
5,5HP (4kW) direct start	●	-	-
7,5HP (5,5kW) direct start	○	●	●
10HP (7,5kW) automatic star-delta start	-	○	○
Saw unit powered lifting and tilting	-	-	●
Automatic brake on main saw blade motor	○	● (○ - no CE)	● (○ - no CE)
Angular cutting device	○	○	○
Angular cutting device with self-adjustment of the stop position	○	○	○
Rip cuttings device	○	○	○
Over head saw guard	○	● (○ - no CE)	● (○ - no CE)
Cutting width of the parallel fence 1000 mm	○	○	○
Cutting width of the parallel fence 1500 mm	○	○	○
3 rotation speeds of the main blade 3000-4000-5000 rpm	-	○	●
Electronic readout for the parallel fence position	-	○	○
Motorized parallel fence with electronic positioning	-	○	○

● = standard ○ = optional

S30 - S40 - S40M

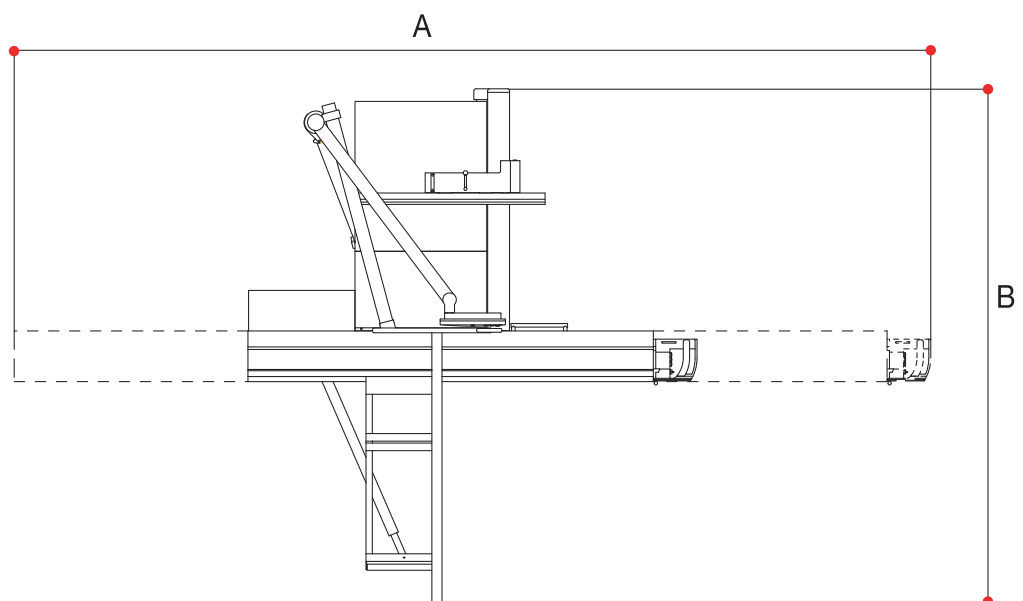

With carriage	A
3200 mm	7250 mm

Cutting width with parallel fence	B
1000 mm	4780 mm
1270 mm	5050 mm
1500 mm	5280 mm

FORMULA

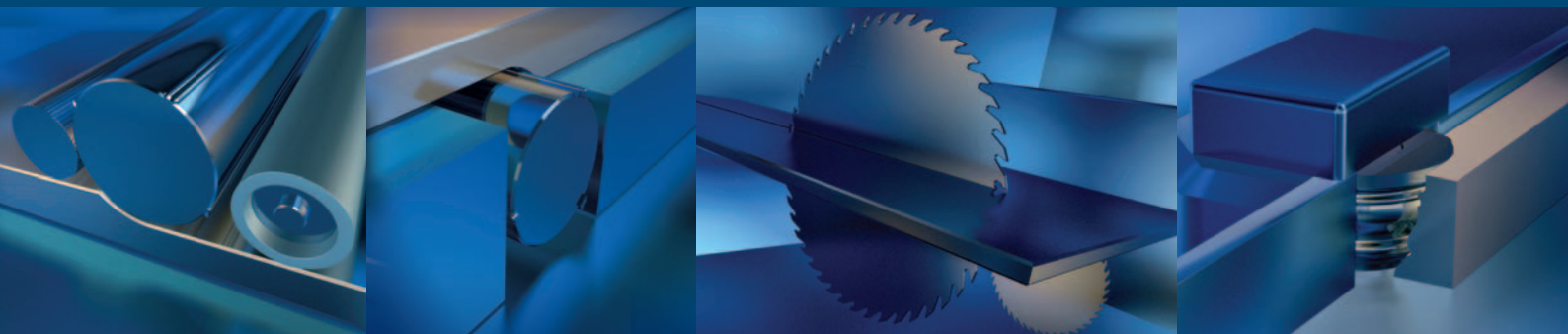

SCM GROUP spa - FORMULA

Via Casale, 450

47826 Villa Verucchio (RN) - Italy

Tel. +39/0541/679578 - Fax +39/0541/674273

www.scmgroup.com - serviceformula@scmgroup.com